

Article number: 203160M1675C4T

Description: E+G levelling foot

GN 31-60-M16-75-C4-T

Note: T Without nut, Wrench flat at the bottom

Measures

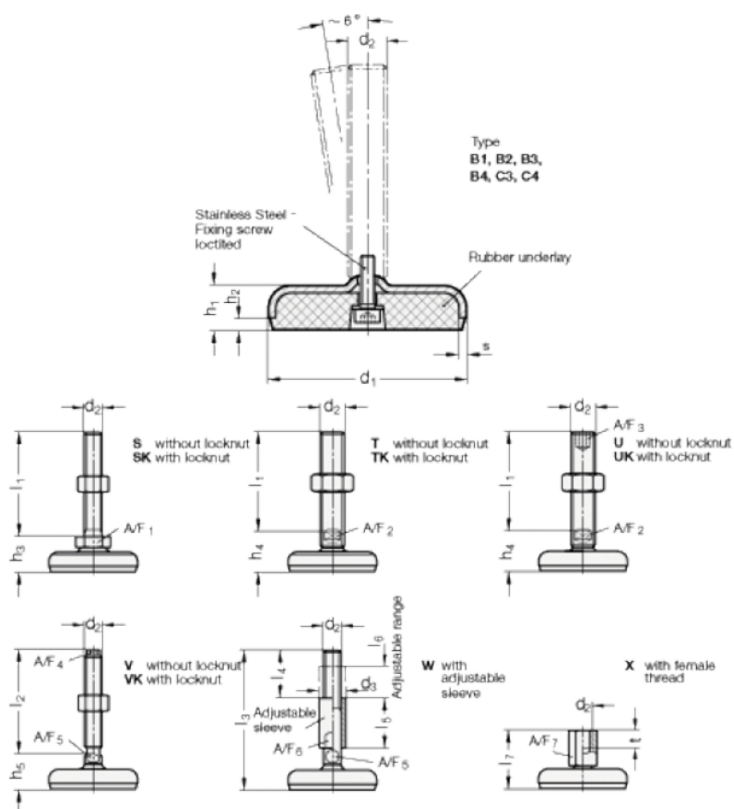

A/F2	= 12
d1	= 60
d2	= 16
h1	= 16
h2	= 4
h4 +4.0/0	= 30
l2	= 75
s	= 3